

Clarke®



VERTICAL AIR COMPRESSORS

MODEL NO: VE11C150, VE15C150, VE18C150

PART NO: 2226005, 2226000, 2226015

OPERATION & MAINTENANCE INSTRUCTIONS



LS0615

INTRODUCTION

Thank you for purchasing this CLARKE Vertical Air Compressors.

Read this manual fully before use and follow the instructions carefully. In doing so you will ensure the safety of yourself and those around you, and you can look forward to your purchase giving you long and satisfactory service.

GUARANTEE

This product is guaranteed against faulty manufacture for a period of 12 months from the date of purchase. Please keep your receipt which will be required as proof of purchase.

This guarantee is invalid if the product is found to have been abused or tampered with in any way, or not used for the purpose for which it was intended.

Faulty goods should be returned to their place of purchase, no product can be returned to us without prior permission.

This guarantee does not effect your statutory rights.

ENVIRONMENTAL RECYCLING POLICY



Through purchase of this product, the customer is taking on the obligation to deal with the WEEE in accordance with the WEEE regulations in relation to the treatment, recycling & recovery and environmentally sound disposal of the WEEE.







In effect, this means that this product must not be disposed of with general household waste. It must be disposed of according to the laws governing Waste Electrical and Electronic Equipment (WEEE) at a recognised disposal facility.

SAFETY PRECAUTIONS

Before using your compressor it is in your own interest to read and pay attention to the following safety rules.

1. Compressed air is dangerous. Do not point a jet of air at persons or animals, and do not discharge compressed air against the skin.
2. DO NOT operate your compressor with the guard removed.
3. Repairs must only be carried out by a qualified engineer. If problems occur, contact your Clarke dealer.
4. Before carrying out any maintenance, make sure that the pressure is released from the air reservoir, and that the compressor is disconnected from the electrical supply.
5. DO NOT leave pressure in the receiver overnight, or when transporting.
6. DO NOT adjust, or tamper with the safety valves. The maximum pressure is factory set, and clearly marked on the compressor.
7. DO NOT operate in wet or damp conditions. Keep the compressor dry at all times. Similarly, clean air will allow the compressor to work efficiently. Do not use in dusty or otherwise dirty locations.
8. Some of the metal parts can become quite hot during operation. Do not touch/ remove these until the compressor has cooled down.
9. Always set the pressure regulator to the recommended setting for the tool.
10. When spraying flammable materials e.g. cellulose paint, ensure that there is sufficient airflow and keep clear of any source of ignition.
11. Before spraying any material always consult paint manufacturers instructions for safety and usage.
12. Protect yourself. Goggles will protect your eyes from flying particles. A face mask will protect you against paint spray and fumes.
13. Do not apply strain to electrical cables and make sure that air hoses are not kinked or wrapped around the compressor.
14. When disconnecting air hoses or other equipment from your compressor, make sure that the air supply is turned off at the outlet and vent all compressed air from within the reservoir and other equipment attached to it.
15. Make sure that children and animals are kept well away from the compressor and any equipment attached to it.
16. Make sure that all individuals using the compressor have had the necessary training and have read and fully understand these operating instructions.
17. Make sure that any equipment or tool used in conjunction with your compressor, has a safe working pressure exceeding that of the compressor.
18. Be **very careful** when transporting the compressor to prevent tipping over
19. Permanently installed systems must be installed by a competent engineer.
20. These compressors produce noise levels in excess of 70dB(A). Persons working near the compressor must be supplied with ear protection.

SAFETY SYMBOLS

| | |
|---|---|
|  | <p>Read this instruction booklet carefully before positioning, operating or adjusting the compressor.</p> |
|  | <p>Risk of electric shock. The compressor must be disconnected from the mains supply before removing any covers. Do not use in a damp environment.</p> |
|  | <p>Risk of accidental start-up. The compressor could start automatically in the event of a power cut and subsequent reset. Do not carry the compressor while it is connected to the power source, or when the tank is filled with compressed air.</p> |
|  | <p>This compressor contains surfaces which may reach a high temperature during operation. Never operate with the motor housing removed.</p> |
|  | <p>Wear safety goggles and ear protectors when using this compressor</p> |
|  | <p>This compressor produces a high sound level during operation. Ear protection should be worn.</p> |

ELECTRICAL CONNECTIONS



WARNING: READ THESE ELECTRICAL SAFETY INSTRUCTIONS THOROUGHLY BEFORE CONNECTING THE PRODUCT TO THE MAINS SUPPLY.

Connect the mains lead to a standard, 230 Volt (50Hz) electrical supply through an approved 13 amp BS 1363 plug, or a suitably fused isolator switch. If the plug has to be changed because it is not suitable for your socket, or because of damage, it must be removed and a replacement fitted, following the wiring instructions shown below. The old plug must be discarded safely, as insertion into a power socket could cause an electrical hazard.



**WARNING: THE WIRES IN THE POWER CABLE OF THIS PRODUCT ARE COLOURED IN ACCORDANCE WITH THE FOLLOWING CODE:
BLUE = NEUTRAL BROWN = LIVE YELLOW AND GREEN = EARTH**

If the colours of the wires in the power cable do not agree with the markings on the plug.

- The BLUE wire must be connected to the terminal which is marked N or coloured black.
- The BROWN wire must be connected to the terminal which is marked L or coloured red.
- The YELLOW AND GREEN wire must be connected to the terminal which is marked E or  or coloured green.

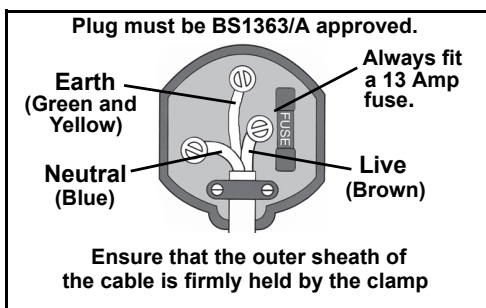

We strongly recommend that this machine is connected to the mains supply through a Residual Current Device (RCD)

If you are not sure, consult a qualified electrician. DO NOT try to do any repairs.

BEFORE USE



WARNING: TO PREVENT INJURY, ALWAYS GET ASSISTANCE WHEN LIFTING OR MOVING THIS COMPRESSOR. ITS DESIGN MEANS IT IS TOP HEAVY.

Before connecting your compressor to the power supply, check the following:-

- Set the ON/OFF switch to the OFF position (pushed down).
- If fitted, remove the protective plastic moulding from the top of the cylinder head.
- Make sure that the supply voltage matches the voltage shown on the data label.
- Make sure that the compressor is on firm level ground.
- This compressor must be secured to the ground through the feet using suitable bolts and washers.

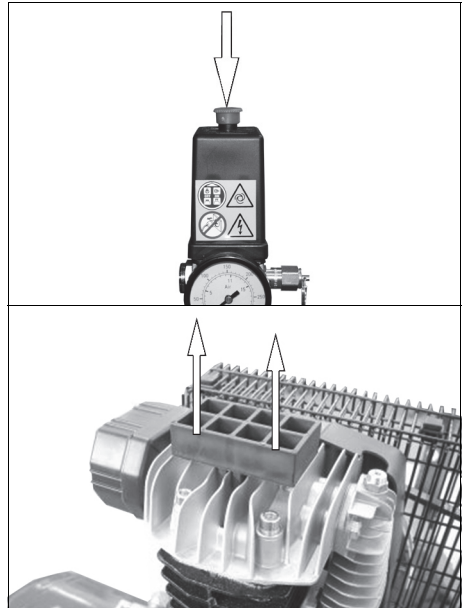

CHECK THE OIL LEVEL

1. Remove the dipstick from the oil reservoir.
 2. Ensure the oil level is between the min and max marks on the dipstick.
- Only use SAE30 compressor oil, available from your Clarke dealer Part No. 3050801
 - Take care not to exceed the maximum mark.

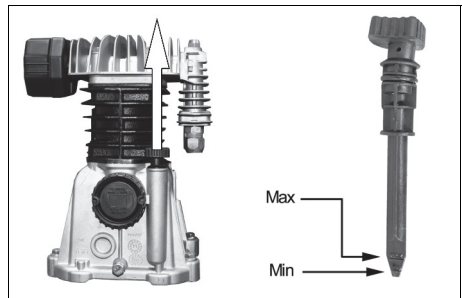

OPERATION

If the compressor has not been used for more than 24 hours, open the drain valve (on the bottom of the reservoir) and drain any condensate which has collected. See page 10.

MOVING THE AIR COMPRESSOR

- Stop the compressor and disconnect it from the power supply before you move it.
- Always get assistance when lifting or moving this compressor as its design means it is top heavy.
- Do not lift by (or put strain on) valves or hoses.

CONNECTING AIR TOOLS



WARNING: BEFORE CONNECTING AIR TOOLS, MAKE SURE THAT YOU READ THE INSTRUCTIONS SUPPLIED WITH THE TOOL, ALSO ENSURE THAT THE TOOL IS SUITABLE FOR USE WITH THE COMPRESSOR AND HOSE SPECIFICATIONS.

1. Attach the air hose to the outlet valve.
2. Attach the air tool to the other end of the air hose.
3. Turn the outlet valve tap to the On position.

NOTE: The outlet valve is shown without the air hose fitted for clarity.

NOTE: To adjust the output pressure we recommend that a pressure regulator (not supplied) be fitted between the compressor and the tool.

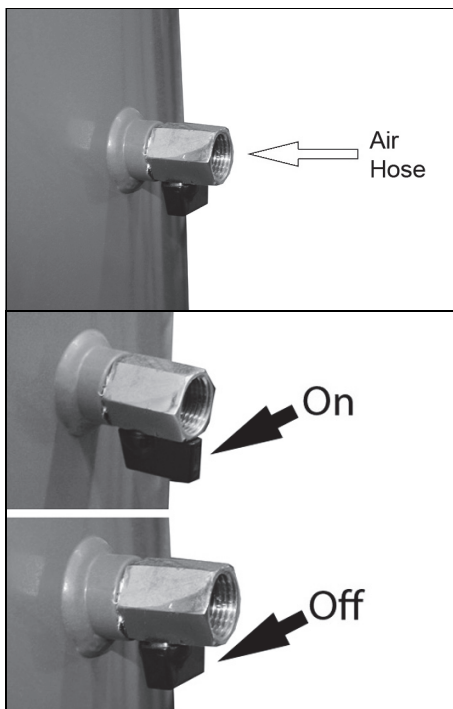

TURNING THE COMPRESSOR ON

1. Plug the compressor into the power supply.
2. Lift the On/Off button.
 - The compressor will operate until the reservoir is fully pressurised. It will then shut down.
 - The compressor will start up again when the pressure in the reservoir decreases.

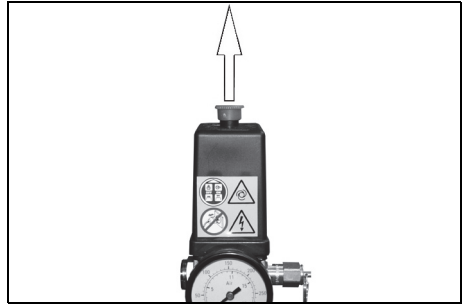

CHECK THE SAFETY VALVE

To make sure that the safety valve works correctly:-

1. Pull on the ring attached.
 - Air will be released when you pull on the ring and stop when released.
2. If the valve does not operate in this way, do not use the compressor. The compressor must be repaired by a qualified service agent.

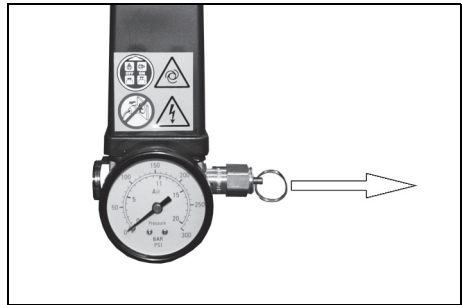

WARNING: DO NOT REMOVE OR TRY TO ADJUST THE SAFETY VALVE.

REMOVING TOOLS FROM THE AIR HOSE



WARNING: ALWAYS SET THE PRESSURE REGULATOR TO ZERO BEFORE YOU REMOVE OR REPLACE A TOOL.

1. Push down on the On/Off button to stop the compressor.



2. Turn the outlet valve handle to the off position.
3. Operate the tool to depressurise the air hose.
4. Disconnect the tool from the hose.

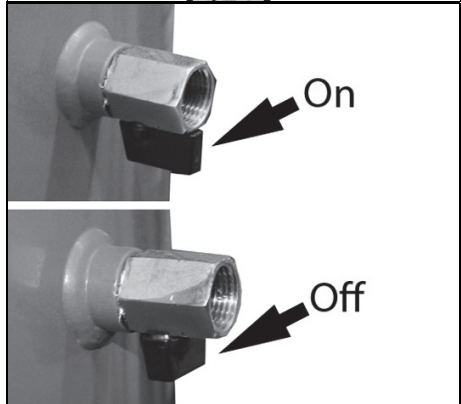

TURNING THE COMPRESSOR OFF

1. Follow steps 1-4 in "Removing Tools From The Air Hose" above.
2. Disconnect the compressor from the power supply.
3. Slowly open the outlet valve to depressurise the reservoir.
 - You will hear a hissing sound as the reservoir depressurises.
4. Do not leave the compressor unattended if the reservoir is pressurised.



DRAINING THE RESERVOIR



CAUTION: YOU MUST DRAIN THE RESERVOIR AFTER EACH DAYS USE AND BEFORE YOU PUT YOUR COMPRESSOR INTO STORAGE.

1. Turn the compressor off and disconnect from the power supply.
2. Put a container below the drain valve to collect the condensate.
 - The drain valve is located on the bottom of the reservoir
3. Open the drain valve slowly.
 - Condensation will drain from the reservoir.
4. Close the drain valve when the reservoir has fully drained.

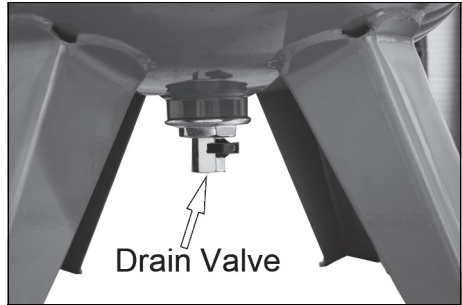

RESET BUTTON

This compressor has a thermal overload device.

If the motor gets too hot, the thermal overload device cuts the power which prevents damage to the motor.

If the thermal overload device operates, let the motor cool down for 5 minutes and push the reset button.

If you start the compressor and the overload cutout operates again, stop the compressor and disconnect from the power supply and have your compressor examined by a qualified service agent.

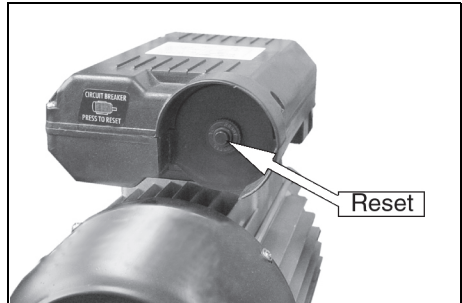

MAINTENANCE



WARNING: MAKE SURE THAT THE COMPRESSOR IS DISCONNECTED FROM THE ELECTRICAL SUPPLY BEFORE CARRYING OUT ANY MAINTENANCE

CHECK OIL (DAILY)

Ensure the oil level is between the min and max marks on the dipstick. See "Check the Oil level" on page 6 and top-up if necessary - (use Clarke SAE30 compressor oil, available from your local dealer).

DRAIN THE RESERVOIR (DAILY)

After use, always open the drain valve to make sure that any condensate is drained off.

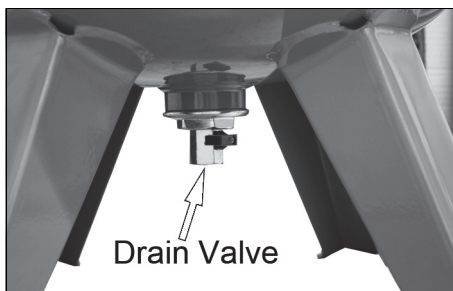

CLEAN THE AIR FILTER (MONTHLY)

The air filter must be examined monthly, more often in dusty conditions,

1. Remove the securing bolt and pull the filter housing from the compressor.
2. Unclip the front and rear of the filter and pull out the filter element.
3. Clean the filter using a soft brush.
 - If necessary, the filter can be carefully cleaned in warm soapy water.
 - Rinse and let the filter dry completely before refitting.
 - If the filter or filter element is damaged, you must replace it.
4. Reassemble the filter and refit it to the compressor using the securing bolt.

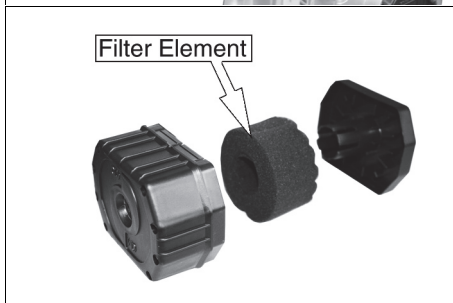
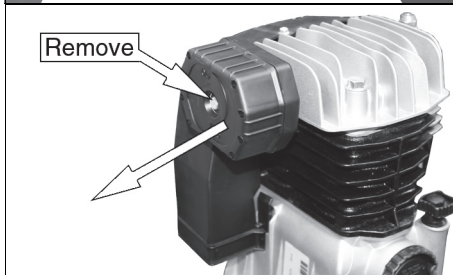

REPLACING THE OIL

After the first 100 hours use, replace the oil using Clarke SAE30 compressor oil. Then replace the oil after every 500 hours of operation or every 6 months.

To empty the oil from the machine, remove the oil drain plug from the crankcase.

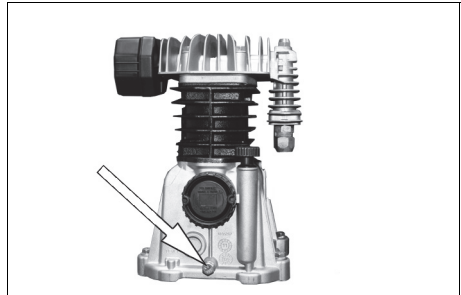

CHECK THE NON-RETURN VALVE (EVERY 6 MONTHS)

If the reservoir pressure decreases for no apparent reason, it is possible that the non-return valve is leaking. To check this:

1. Make sure that the reservoir is not under pressure and the compressor is switched OFF.
2. Examine the non-return valve, and replace the gasket and valve if necessary.

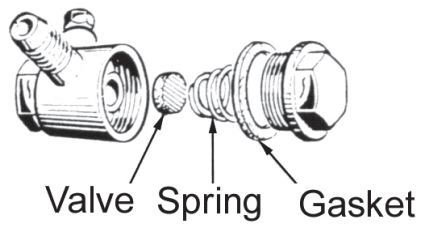
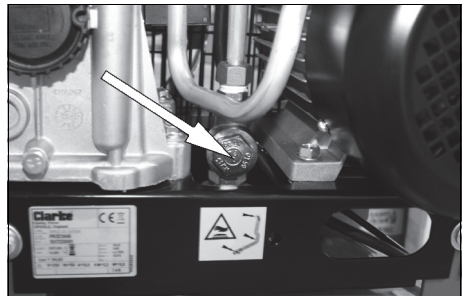

REPLACING THE DRIVE BELT



WARNING: MAKE SURE THAT THE COMPRESSOR IS DISCONNECTED FROM THE ELECTRICAL SUPPLY BEFORE REPLACING THE DRIVE BELT.

1. Rotate the clips on the front of the safety cage.
2. Remove the front of the cage and take out the worn or broken drive belt.

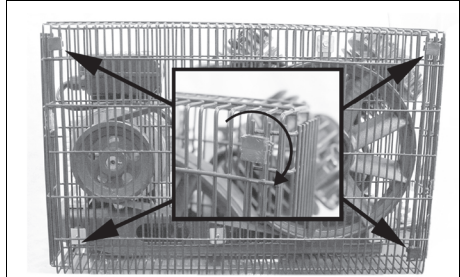

3. Place the new drive belt over the small wheel.

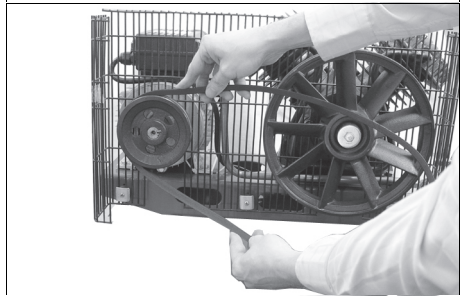

4. Position part of the drive belt over the large belt wheel as shown.

5. Rotate the large belt wheel by hand in a clockwise direction whilst guiding the belt on to it.

- Take care to avoid trapping your fingers between the wheel and belt.

6. Replace the cage and secure before use.

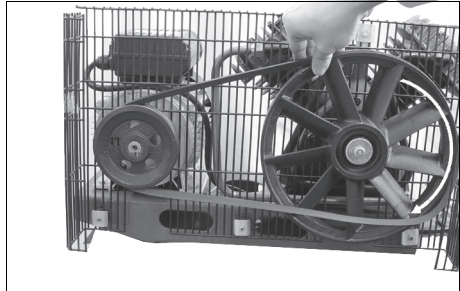

NOTE: Never use the compressor with the guard removed.

SPECIFICATIONS

| MODEL | VE11C150 | VE15C150 | VE18C150 |
|------------------------|-----------------|-----------------|-----------------|
| Part Number | 2226000 | 2226005 | 2226015 |
| Max Pressure | 10 bar | 10 bar | 10 bar |
| Voltage | 230V AC@50 Hz | 230V AC@50 Hz | 230V AC@50 Hz |
| Air Displacement | 9 cfm | 14 cfm | 18 cfm |
| Receiver Capacity | 150 L | 150 L | 150 L |
| Dimensions (L x W x H) | 620x500x1610 mm | 620x500x1630 mm | 620x500x1630 mm |
| Weight | 100 kg | 110 kg | 125 kg |

Please note that the details and specifications contained herein, are correct at the time of going to print. We reserve the right to change specifications at any time without prior notice.

TROUBLESHOOTING



CAUTION: DO NOT TRY TO REPAIR OR ADJUST IF YOU ARE UNCERTAIN. IF YOU HAVE ANY QUERIES, CONTACT YOUR CLARKE DEALER.

| PROBLEM | PROBABLE CAUSE | REMEDY |
|---|--|--|
| The compressor has stopped and does not start. | Bad electrical connections. | <ol style="list-style-type: none"> 1. Check electrical connections. 2. Clean and tighten if necessary. |
| | Thermal overload cutout switch has tripped. | <ol style="list-style-type: none"> 1. Switch off and wait approx 5 minutes. 2. Press the reset button and switch on again. |
| | Motor windings burnt out. | <ol style="list-style-type: none"> 1. Contact your Clarke dealer for a replacement motor. |
| The compressor does not reach the set pressure and overheats easily. | Compressor head gasket blown or valve broken. | <ol style="list-style-type: none"> 1. Return the machine to your nearest service agent. |
| Compressor does not start. | The reservoir has already fully pressurised. | <ol style="list-style-type: none"> 1. Open drain valve to expel air. Compressor should start again when pressure reduces. |
| Air leaking from the non-return valve when the compressor is not running. | Faulty non-return valve. | <ol style="list-style-type: none"> 1. Drain receiver completely of air. 2. Remove the valve end plug, 3. Carefully clean the valve seat and the gasket. 4. Reassemble. |
| Air pressure from the regulator will not adjust. | The diaphragm within the regulator body is broken. | <ol style="list-style-type: none"> 1. Replace regulator. |
| The compressor is very noisy and makes a metallic knocking sound. | Compressor damaged and needs overhaul. | <ol style="list-style-type: none"> 1. Return the machine to your nearest service agent. |

DECLARATION OF CONFORMITY



Clarke[®]
INTERNATIONAL

Hemncall Street, Epping, Essex CM16 4LG

DECLARATION OF CONFORMITY

This is an important document and should be retained.

We, Clarke International, as the authorised representative of the manufacturer, declare that the following product(s) comply with the directive(s) and standard(s) listed below.

Product Description: Vertical Air Compressor(s)
Model number(s): VE11C150 1 Phase
VE15C150 1 Phase
VE15C150 3 Phase
VE18C150 1 Phase
VE18C150 3 Phase
VE25C150 3 Phase

Serial / batch Number: N/A

Notified Body: N/A.....
.....
.....
.....

Technical Documentation Holder: A.R. Pond
Clarke International
2a Shrubland Road
London E10 7RB
UK

DECLARATION OF CONFORMITY



Clarke[®]
INTERNATIONAL

Hemnall Street, Epping, Essex CM16 4LG

DECLARATION OF CONFORMITY

This is an important document and should be retained.

Directive(s):

2004/108/EC *Electromagnetic Compatibility Directive.*

2006/42/EC *Machinery Directive.*

2009/105/EC *Simple Pressure Vessel Directive.*

Standard (s):

EN 1012-1, EN 60204-1, EN 61000-6-3/4.

The technical documentation required to demonstrate that the product(s) meet(s) the requirement(s) of the aforementioned directive(s) has been compiled and is available for inspection by the relevant enforcement authorities.

The CE mark was first applied in: 2011

Signed:



J.A. Clarke
Director

Date of issue:

10/06/2015

Place of issue:

Clarke International
Hemnall Street
Epping
Essex, CM16 4LG
England

ALSO AVAILABLE FROM CLARKE

Your local Clarke stockists can supply a wide choice of accessories to help you make the very best of your air compressor. These include:

KIT1000



5 Piece Air Accessory Kit – KIT100

Kit comprises:

- Paint spray gun • Recoil hose • Paraffin gun
- Tyre inflator with gauge • Blow gun • All connections 1/4" BSP
- Weight 2kg



CAT116
3/8" Air Drill



CAT118
Sabre Saw

CAT121
Dual
Action
Sander



CAT108
1/2" Square
Drive
Reversible
Ratchet



CAT109
3/8" Square
Drive
Reversible
Ratchet



CAT115
1/2" Reversible
Ratchet



CAT110
1/2" Square
Drive
Impact
Wrench



CAT117
1/2" Impact
Wrench



CAT111
Orbital
Sander



CAT113
3" CUT-OFF TOOL



A comprehensive choice of Clarke spraying equipment is available for your air compressors, including:



PRO12

This professional spraygun is available with a choice of nozzle sizes to suit air compressors from 1.5HP – 3HP.



TG2

Touch up gun ideal for precision paint spraying and touch up work. This syphon fed, external mix spraygun is popular with professionals.

Air hose is available in a range of lengths. Amongst the most popular are:



BLACK RUBBER AIR HOSE

Complete with connections, this hose is available in lengths from 10m to 50m



RECOIL HOSE

Ideal for DIY and professional use, this recoil hose is available in a range of lengths

NOTES

A SELECTION FROM THE VAST RANGE OF

Clarke®

QUALITY PRODUCTS

AIR COMPRESSORS

From DIY to industrial, Plus air tools, spray guns and accessories.

GENERATORS

Prime duty or emergency standby for business, home and leisure.

POWER WASHERS

Hot and cold, electric and engine driven - we have what you need

WELDERS

Mig, Arc, Tig and Spot. From DIY to auto/industrial.

METALWORKING

Drills, grinders and saws for DIY and professional use.

WOODWORKING

Saws, sanders, lathes, mortisers and dust extraction.

HYDRAULICS

Cranes, body repair kits, transmission jacks for all types of workshop use.

WATER PUMPS

Submersible, electric and engine driven for DIY, agriculture and industry.

POWER TOOLS

Angle grinders, cordless drill sets, saws and sanders.

STARTERS/CHARGERS

All sizes for car and commercial use.



PARTS & SERVICE: 0208 988 7400

E-mail: Parts@clarkeinternational.com or Service@clarkeinternational.com

SALES: UK 01992 565333 or Export 00 44 (0)1992 565335

Clarke® INTERNATIONAL Hemnall Street, Epping, Essex CM16 4LG
www.clarkeinternational.com